

How does clinical staff participation in research change with a dedicated staff role focusing on academic support?

Kylie Dundas^{1,2,3}, Melissa Grand^{1,2}, Rhiannon Louis^{1,2}, Lois Holloway^{1,2,3,4,5}.

- 1. Ingham Institute Applied Medical Research, Liverpool, Sydney*
- 2. South Western Sydney Radiation Oncology, South Western Sydney Local Health District*
- 3. South Western Sydney Clinical School, University of New South Wales*
- 4. Centre for Medical Radiation Physics, University of Wollongong*
- 5. Institute of Medical Physics, University of Sydney*



Introduction

- Clinical research groups:
 - challenge traditional distinctions between research & QI
 - link discovery with application,
 - Integrate research with practice
 - reduces research waste
 - increases likelihood of clinical application
 - can be quite burdensome to already time poor clinicians¹⁻⁶.

Introduction – SWS Radiation Oncology Service

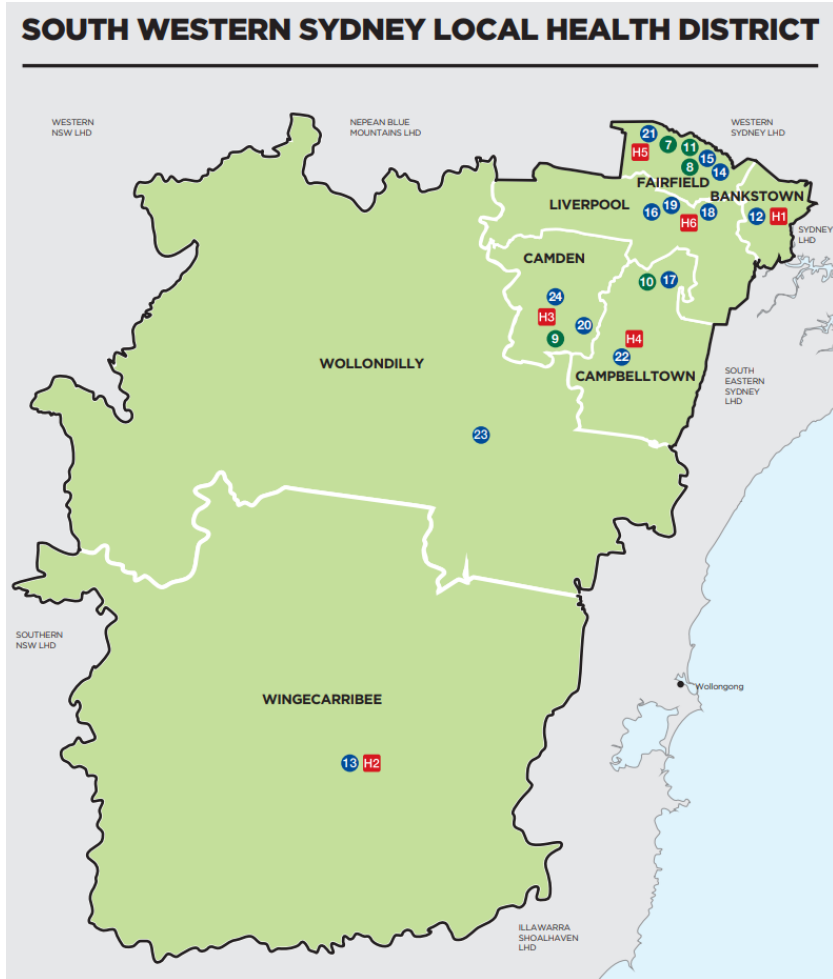

TOTAL NSW RADIOTHERAPY TREATMENT MACHINES

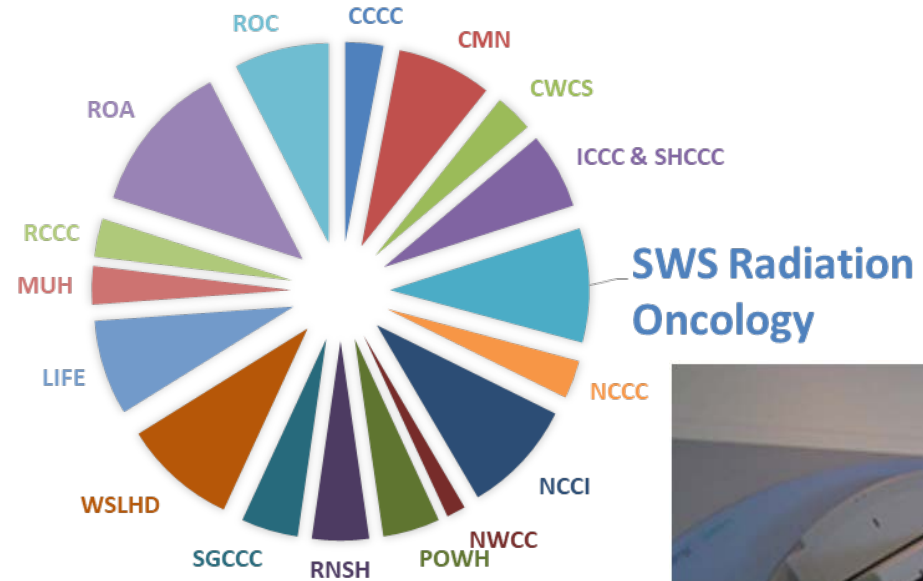

Introduction – SWS Radiation Oncology Service

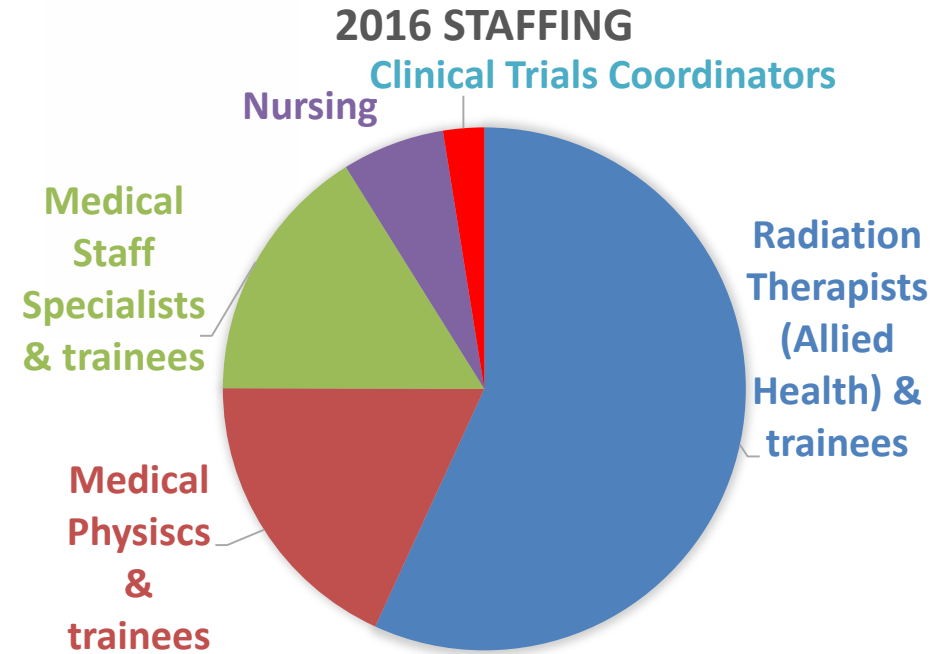
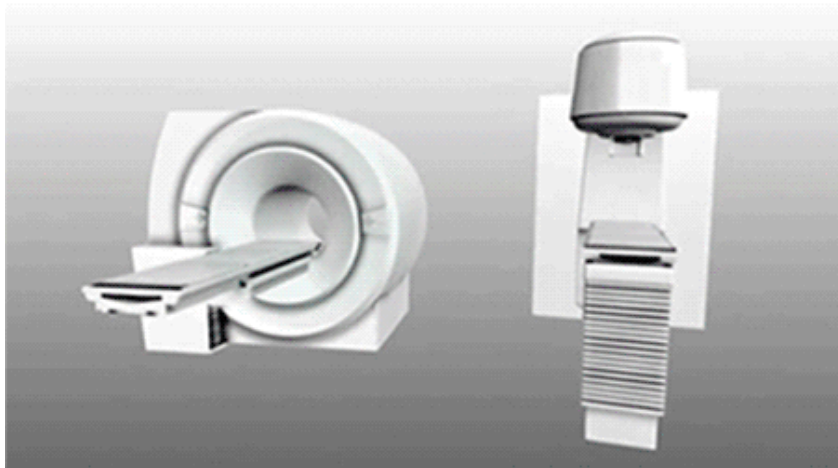

Introduction – SWS Radiation Oncology Academic Unit

- 2015-2017 – Academic Unit Grant SWSLHD
- Funding used to employ:
 - Research Projects Coordinator
 - Research Administrative Assistant
 - Support both the Research Executive Committee and research staff within the department.
 - Separate to clinical trials team



SOUTH WESTERN SYDNEY
Academic Unit



Objective

- Examine how clinical staff participation in research changed with dedicated staff focusing on academic support
 - governance
 - research conduct training



Method

- Trends in research growth were assessed using data obtained from departmental records from 2011 to 2017.

Results - Clinical Staff Actively Involved In Research

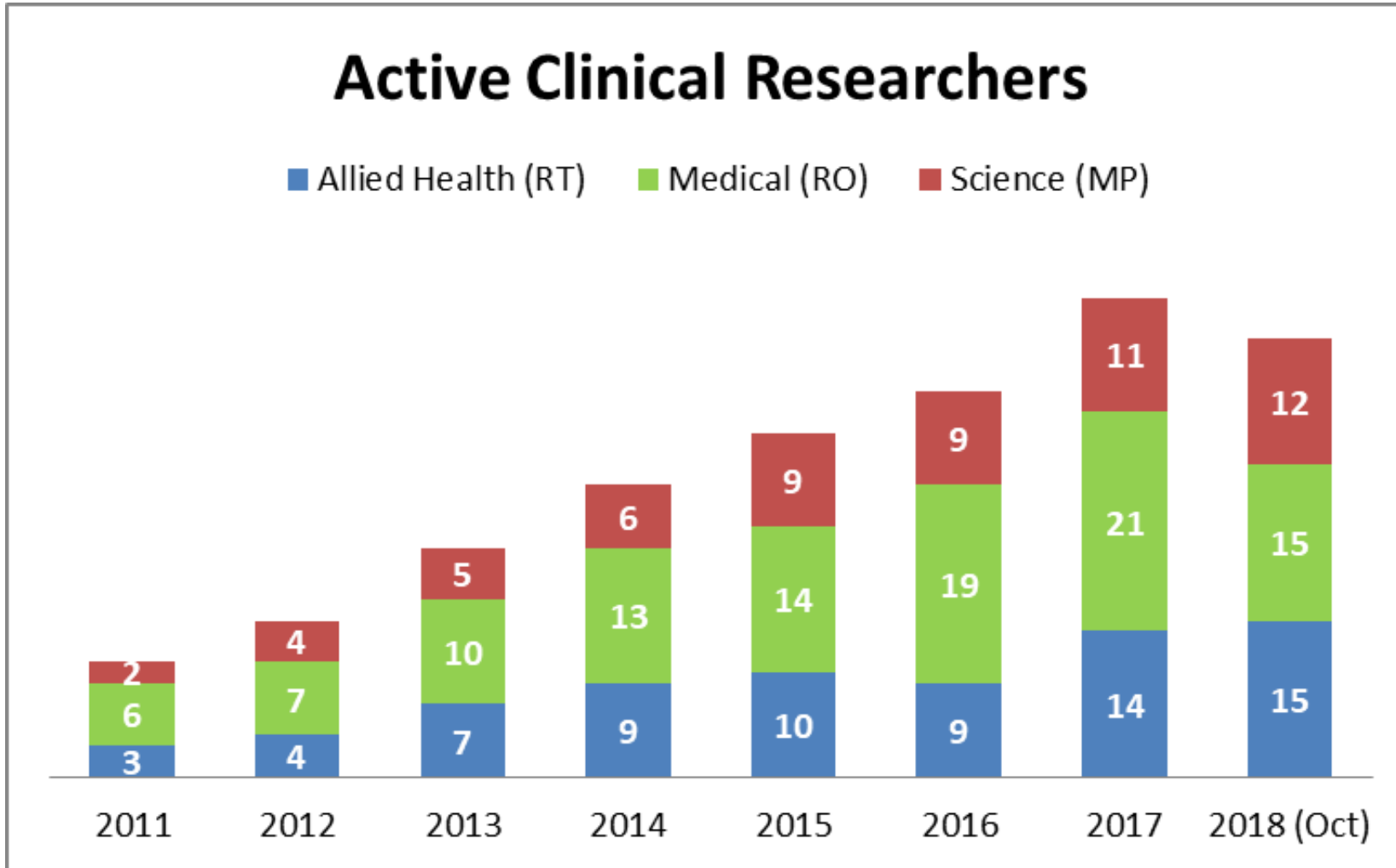

Results – Number of Open/Active Research Projects

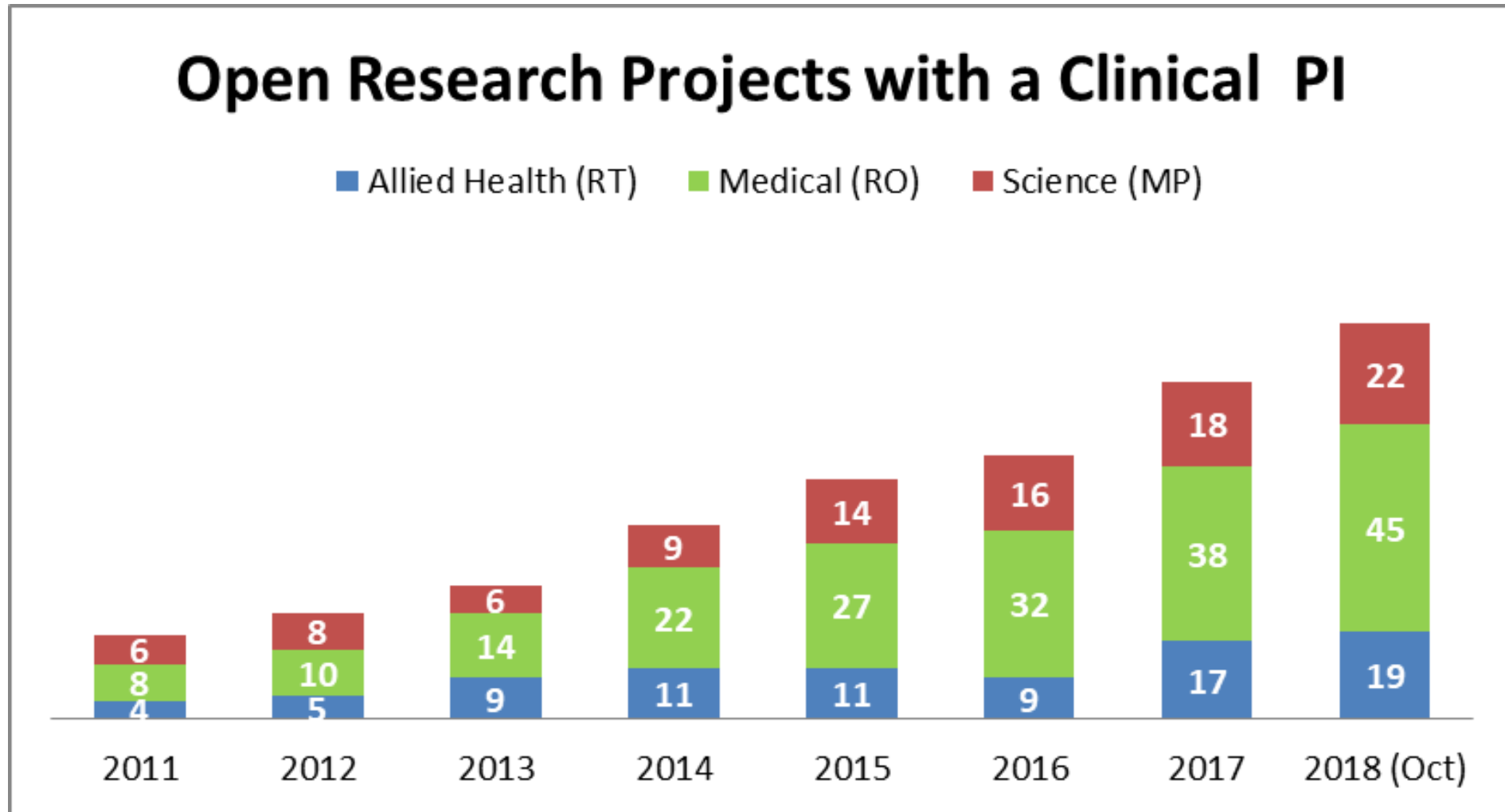

Results - Clinical Staff with GCP Training

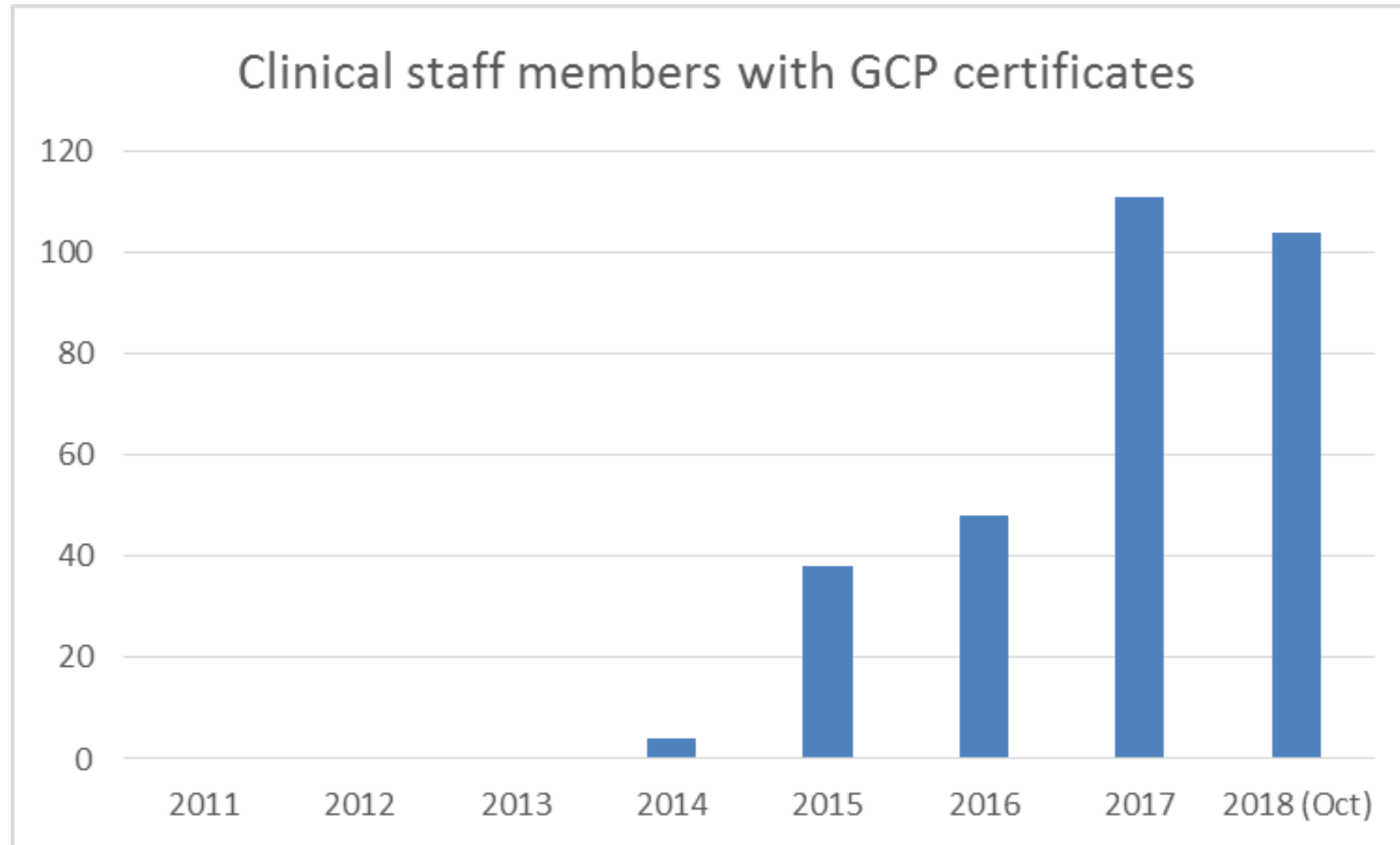

Results – Investigator Initiated Clinical Trials

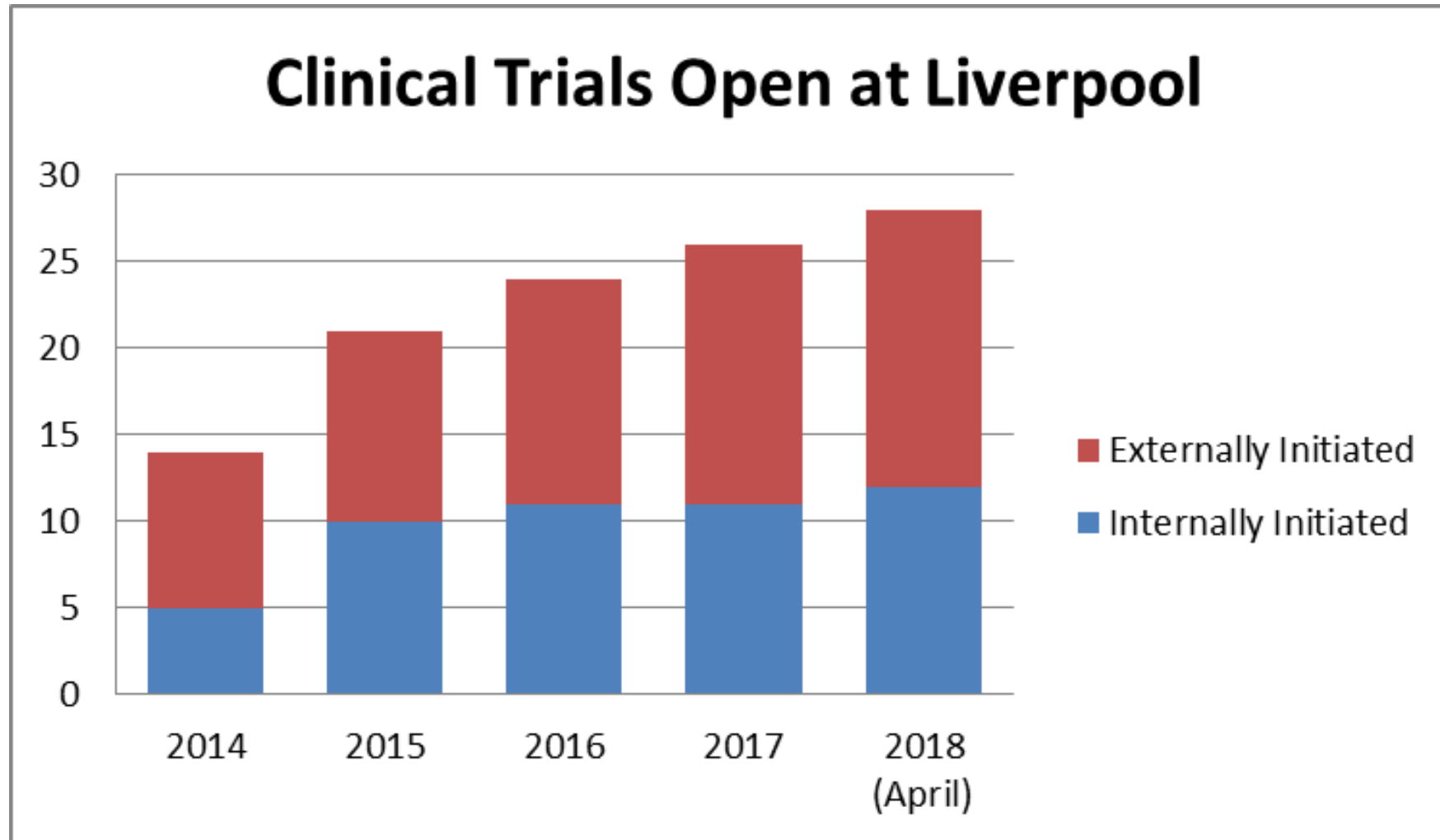

Results – Research Students

PhD Students Grouped by Institution School

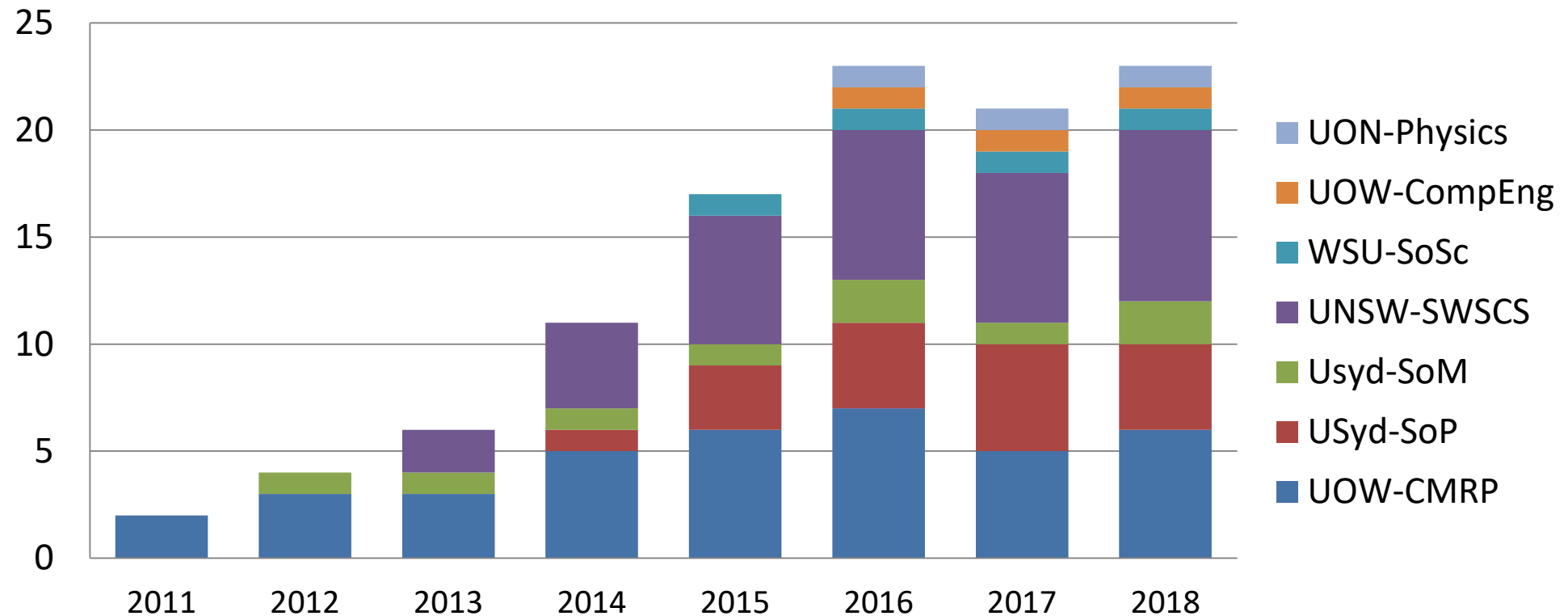

Results – Paid Research Positions

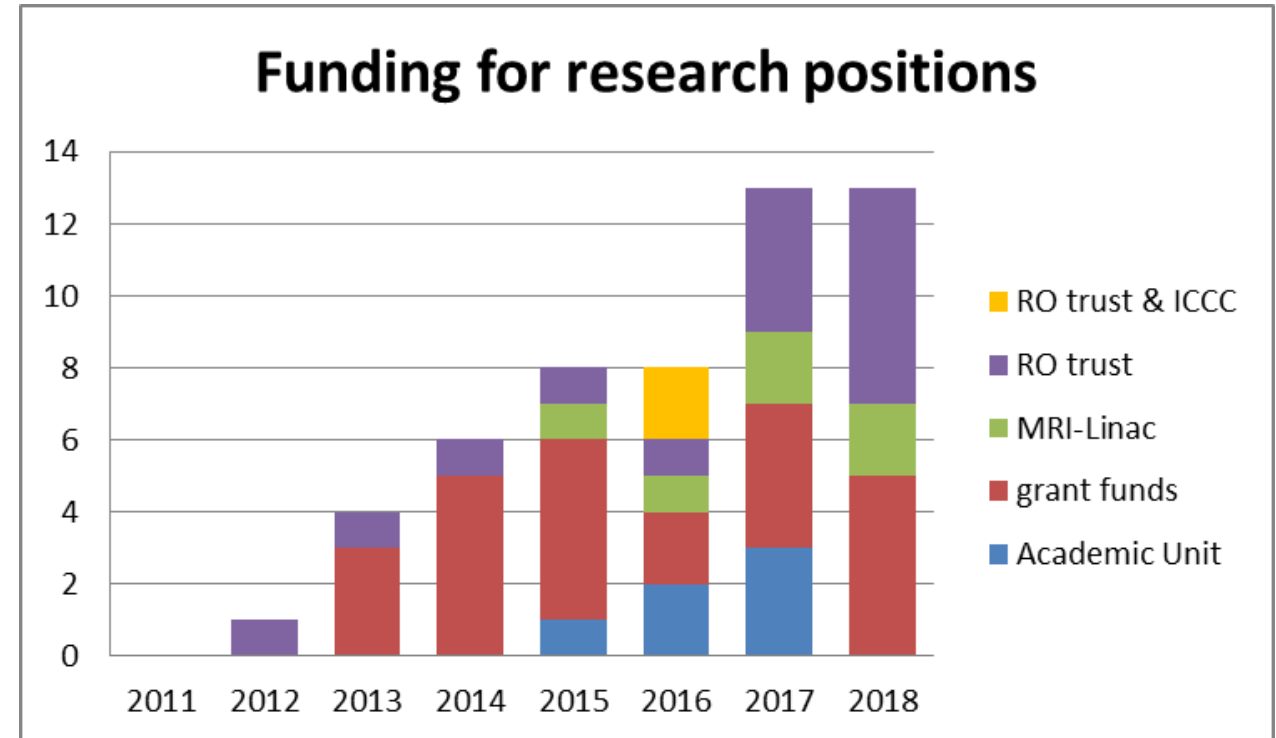
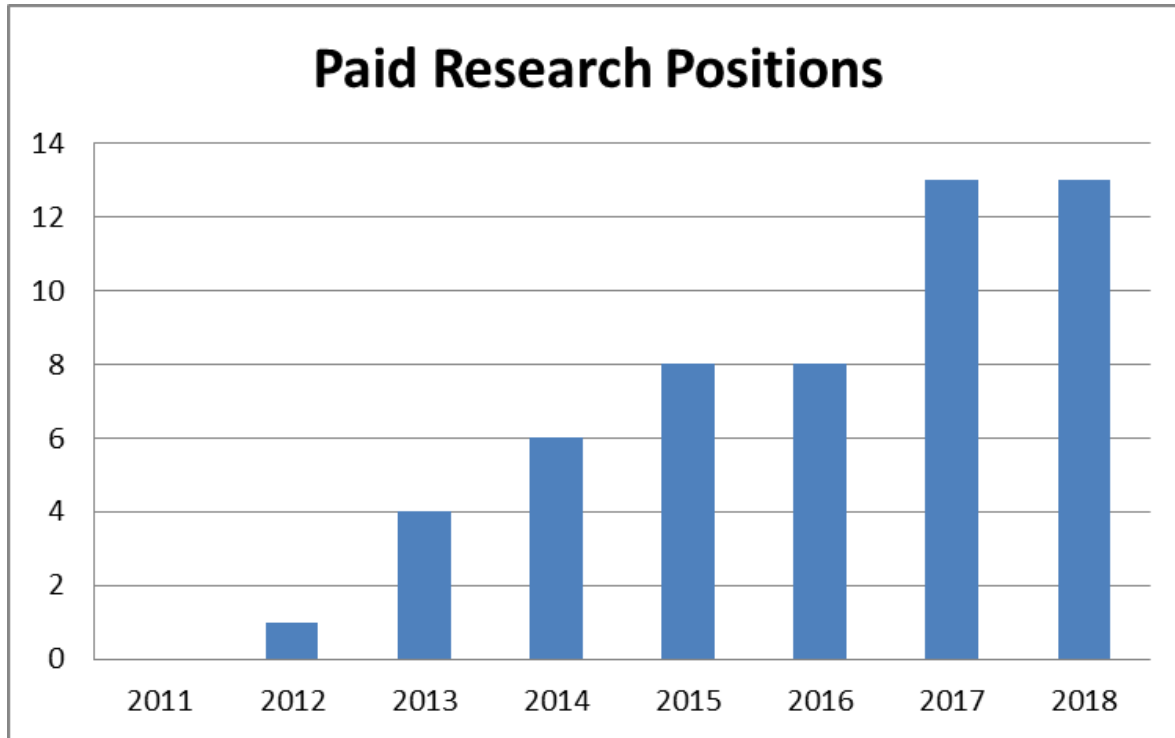

Discussion –





Conclusions

- Dedicated research support roles has contributed to the growth of clinical researchers and increased the research activity in our department.
 - Increase in research training (GCP)
 - Increase in clinical staff participation in research projects
 - Increase in paid research positions and students
 - Governance duties no longer dominating senior research and staff members time
- Positions are still funded.



Acknowledgments

- SWSLHD Ethics and Research Office for the Academic Unit Grant.
- Radiation oncology clinical and research staff and research students at Liverpool and Macarthur Cancer Therapy Centres and the Medical Physics group at the Ingham Institute.
- Dr Dion Forstner - the Director of Radiation Oncology at the time of the academic unit grant.
- Yobelli Jimenez, the first research administrative assistant.



References

1. Lenfant, C., *Clinical Research to Clinical Practice — Lost in Translation?* New England Journal of Medicine, 2003. **349**(9): p. 868-874.
2. Milat, A.J., A.E. Bauman, and S. Redman, *A narrative review of research impact assessment models and methods.* Health Research Policy and Systems, 2015. **13**(1): p. 1.
3. Minasian, L.M., W.R. Carpenter, B.J. Weiner, D.E. Anderson, W. McCaskill-Stevens, S. Nelson, C. Whitman, J. Kelaghan, A.M. O'Mara, and A.D. Kaluzny, *Translating research into evidence-based practice.* Cancer, 2010. **116**(19): p. 4440-4449.
4. Salnan, R.A.-S., E. Beller, J. Kagan, E. Hemminki, R.S. Phillips, J. Savulescu, M. Macleod, J. Wisely, and I. Chalmers, *Increasing value and reducing waste in biomedical research regulation and management.* The Lancet, 2014. **383**(9912): p. 176-185.
5. Macleod, M.R., S. Michie, I. Roberts, U. Dirnagl, I. Chalmers, J.P.A. Ioannidis, R.A.-S. Salnan, A.-W. Chan, and P. Glasziou, *Biomedical research: increasing value, reducing waste.* The Lancet, 2014. **383**(9912): p. 101-104.
6. Mold, J.W. and K.A. Peterson, *Primary care practice-based research networks: working at the interface between research and quality improvement.* Ann Fam Med, 2005. **3 Suppl 1**: p. S12-20.
7. Currow D, Thomson W, Bailey K. *Radiotherapy Treatment Services to NSW Residents: 2016 Annual Report.* Sydney: Cancer Institute NSW. December, 2017.